

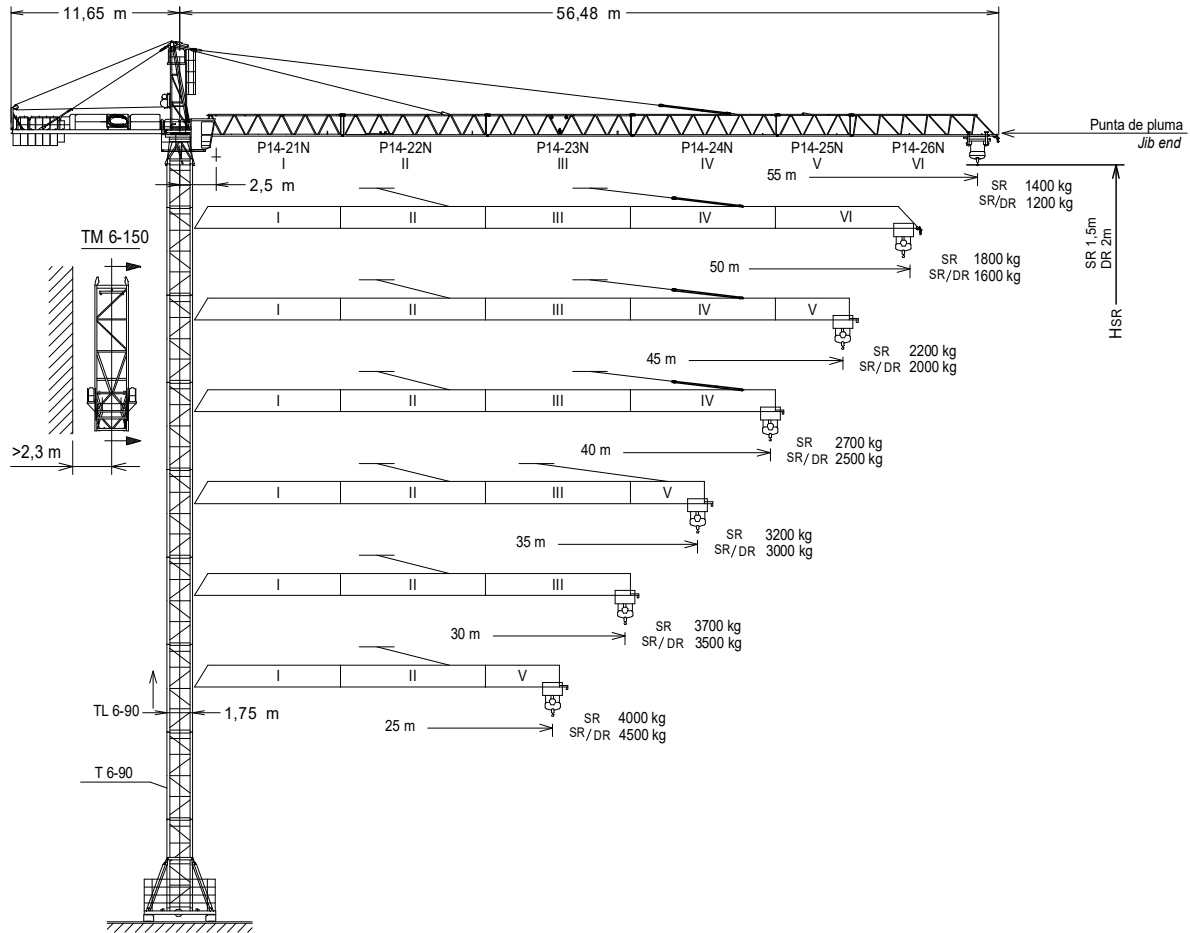

UNE 58-101
FEM 1001

UNE-EN-ISO 9001



H_{DR} = H_{SR}-0,5

Altura máxima bajo gancho sin arriostrar (m).
Maximum height under hook without fastening (m).

Hauteur maximale sous crochet sans ancrage (m).

H_{SR} = Максимальная высота под крюком без крепления (m).
Bağlantısız maksimum kanca altı yüksekliği (m).

أقصى ارتفاع تحت الخطاف بدون ربط (m)

* Punta de pluma / Jib end / Pointe de flèche / Конец стрелы / Вотусу / مقدمة الذراع

TM 6-150	161.35.700	BNI 45-100	145.20.500
T 3-90	133.32.000	BNI 6-150	161.20.000
TL 3-90	158.32.000	ABH 100	201.23.000
T 6-90	133.31.000	P14-21N	158.40.000
TL 6-90	158.31.000	P14-22N	158.41.000
T 6-150	161.31.000	P14-23N	158.42.000
T 6-150A	161.31.300	P14-24N	158.43.000
AN 90	133.21.000	P14-25N	158.44.000
AN 150	161.21.000	P14-26N	158.45.500
BN3-150	161.20.800	Punta de pluma/Jib end*	158.46.000

(H) TRASLACIÓN / TRAVELLING /

TRASLATION / ПЕРЕМЕЩЕНИЕ / RAY YÜRÜYÜŞLÜ / متحركة

(H) ESTACIONARIA / STATIONARY /

STATIONAIRE / СТАЦИОНАРНОЕ СОСТОЯНИЕ / SABIT / ثابتة

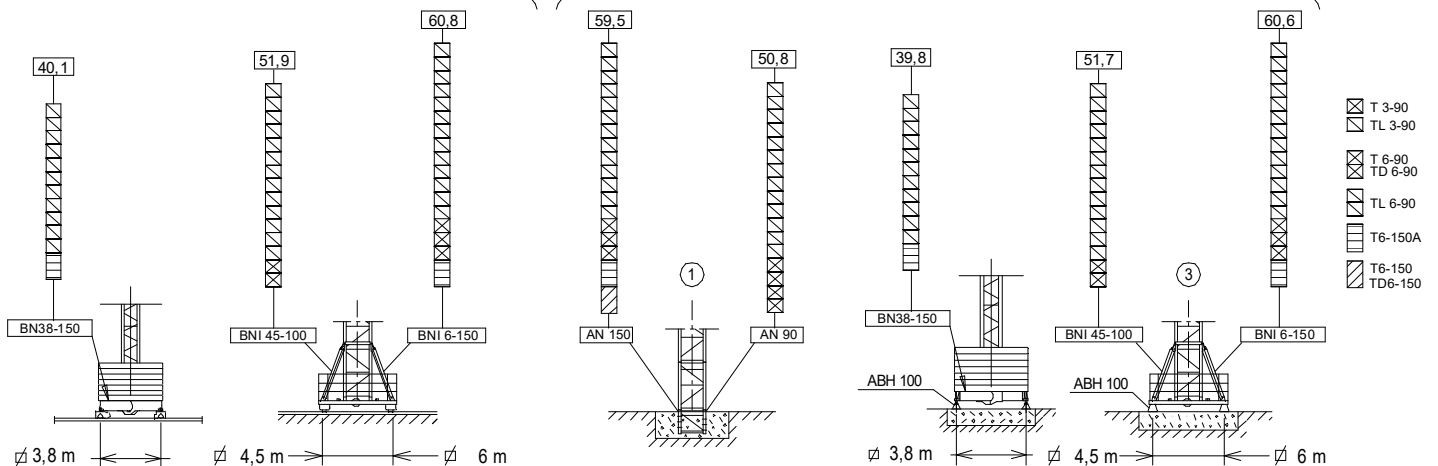



Fecha / Date: 18/02/2021



FEM 1001







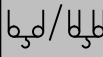

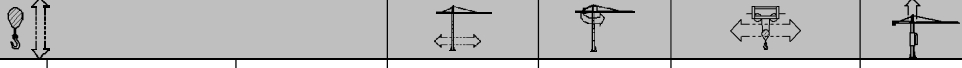

Reservado el derecho a modificaciones sin previo aviso. Declinamos toda responsabilidad derivada de la información proporcionada / Subject to modification, without previous warning. This information is supplied without liability / L'entreprise se réserve le droit de procéder à des modifications sans préavis. Nous déclinons toute responsabilité quant aux informations fournies / Мы оставляем за собой право на внесение изменений без предварительного уведомления. Мы снимаем с себя любую ответственность в отношении предоставленной информации / Onceden bildirilmeksizin değiştirilme hakkı saklıdır. Verilen bilgiler için hiçbir sorumluluk kabul etmemekteyiz / حقوق التغيير محفوظة دون إشعار مسبق. دون أدنى مسؤولية عن المعلومات المقدمة

CARGAS / LOADS / CHARGES / НАГРУЗКИ / YÜKLER / الأحمال **J85**

 SR (kg)		Cargas máximas / Maximum loads / Charges maximales / Максимальные нагрузки / Maksimum yük / أقصى حمولة SR1 - 3.000 kg SR2 - 4.000 kg							
 [m]	3000-4000 kg @ ... (m)	Alcance del gancho [m] / Hook reach [m] / Portée du crochet (m) / Радиус действия крюка (m) / Kancanın yüksekliği (m) / مدى الخطاف							
		25	30	35	40	45	50	55	
55 m	29,12-22,5	3000-3560	2900	2430	2075	1800	1580	1400	
50 m	32,35-25,0	3000-4000	3000-3265	2745	2350	2045	1800	-----	
45 m	34,41-26,59	3000-4000	3000-3500	2945	2525	2200	-----	-----	
40 m	36,47-28,18	3000-4000	3000-3735	3000-3145	2700	-----	-----	-----	
35 m	35,0-28,64	3000-4000	3000-3800	3000-3200	-----	-----	-----	-----	
30 m	30,0-27,95	3000-4000	3000-3700	-----	-----	-----	-----	-----	
25 m	25,0	3000-4000	-----	-----	-----	-----	-----	-----	

 SR / DR (kg)		Cargas máximas / Maximum loads / Charges maximales / Максимальные нагрузки / Maksimum yük / أقصى حمولة SR1 / DR1 - 3.000 / 6000 kg								
 [m]	3000 / 6000 kg @ ... (m)	Alcance del gancho [m] / Hook reach [m] / Portée du crochet (m) / Радиус действия крюка (m) / Kancanın yüksekliği (m) / مدى الخطاف								
		15	20	25	30	35	40	45	50	55
55 m	27,5 / 15,0	3000 / 6000	3000 / 4350	3000 / 3360	2700	2230	1875	1600	1380	1200
50 m	30,56 / 16,67	3000 / 6000	3000 / 4900	3000 / 3800	3000 / 3065	2540	2150	1845	1600	-----
45 m	32,5 / 17,75	3000 / 6000	3000 / 5250	3000 / 4080	3000 / 3300	2745	2325	2000	-----	-----
40 m	34,44 / 18,79	3000 / 6000	3000 / 5600	3000 / 4360	3000 / 3535	2945	2500	-----	-----	-----
35 m	35,0 / 19,09	3000 / 6000	3000 / 5700	3000 / 4440	3000 / 3600	3000	-----	-----	-----	-----
30 m	30,0 / 18,64	3000 / 6000	3000 / 5550	3000 / 4320	3000 / 3500	-----	-----	-----	-----	-----
25 m	25,0 / 19,32	3000 / 6000	3000 / 5775	3000 / 4500	-----	-----	-----	-----	-----	-----

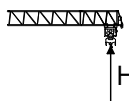
CARACTERISTICAS DE MECANISMOS / MECHANISMS FEATURES / CARACTÉRISTIQUES DES MÉCANISMES / ХАРАКТЕРИСТИКИ МЕХАНИЗМОВ / MEKANİZMALARIN ÖZELLİKLERİ / الخصائص الآلية **J85**

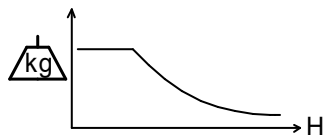
*opcional *optional *en option *опция *opsiyonel *اختياري								
	EC2556 SR1 18,4 kW	* EC3380VF SR1 24,2 kW	EC2544 SR2 18,4 kW	* EC3360VF SR2 24,2 kW	TG1125VF 2x4 kW	OG1108VF 2x4 kW	TC465VF 3 kW	TH1210 9,2 kW
 m/min	1,5 3 3 56 28 7	1,5 3 0...80 0...40	2 4 4 44 22 5,5	2 4 0...60 0...30	0...25 m/min	0...0,8 r/min / sl/min	0...15 15...32 32...65 m/min	1 m/min
 m/min	3 6 6 28 14 4	3 6 0...40 0...20						
 H	H ≤ SR 240 m DR 120 m		SR 272m		⚡ P_{TOTAL} (EC25XX + OG1108VF + TC465VF) = 29,4 kW P_{TOTAL} (*EC33XXVF + OG1108VF + TC465VF) = *35,2 kW 400V 50Hz			
					⚡ 480V 60Hz EC2556 EC2544 TH1210 kW +20% m/min +20%			



Fecha / Date: 18/02/2021



 **FEM 1001**

Reservado el derecho a modificaciones sin previo aviso. Declinamos toda responsabilidad derivada de la información proporcionada / Subject to modification, without previous warning. This information is supplied without liability / L'entreprise se réserve le droit de procéder à des modifications sans préavis. Nous déclinons toute responsabilité quant aux informations fournies / Мы оставляем за собой право на внесение изменений без предварительного уведомления. Мы снимаем с себя любую ответственность в отношении предоставленной информации / Onceden bildirimeksizin değiştirilme hakkı saklıdır. Verilen bilgiler için hiçbir sorumluluk kabul etmemekteyiz / حقوق التغيير محفوظة دون إشعار مسبق. دون أدنى مسؤولية عن المعلومات المقدمة

LISTA DE EMBARQUE / PACKING LIST /

J85

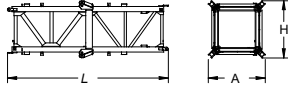
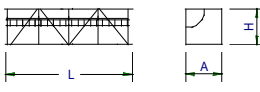
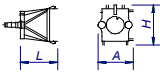
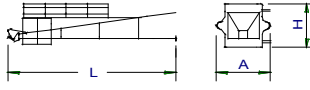
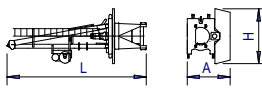
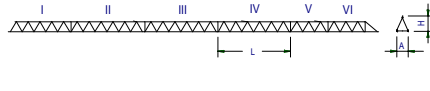
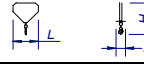
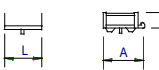
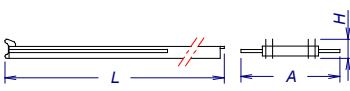
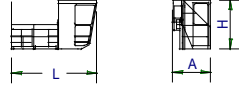
LISTE DE COLISAGE / СПИСОК ПОСТАВКИ / ÇEKİ LİSTESİ / قائمة التحميل

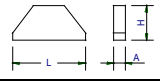
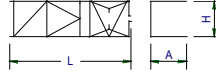
DENOMINACIÓN / DENOMINATION / DÉSIGNATION / НАЗВАНИЕ / AÇIKLAMA / اسم		L [m]	A [m]	H [m]	P / W [kg]	
Torre inferior / Lower tower / Tour inférieure Нижняя башня / Alt kule / البرج السفلي	T16-90 T16-150		6,146 6,175	2,085 2,190	2,085 2,190	2500 3535
Torre Tower Tour Башня Kule برج	T3-90 TL3-90 T6-90 TL6-90 T6-150 T6-150A		3,190 3,196 6,140 6,136 6,175 6,175	1,818 1,818 1,818 1,818 1,870 1,870	1,818 1,818 1,818 1,818 1,870 1,870	1200 960 2250 1785 2760 2760
Torre asiento pista + base punta de torre + orientación Slewing table + tower head base + slewing mechanism Tour pivot + base du porte-flèche + mécanisme d'orientation Сиденье площадки + основание верхней секции башни + поворотный механизм Göbek + kule kafa bölümü tabanı + mekanizma برج وحدة الدوارن + قاعدة رأس البرج + آلية الدوران			3,390	2,060	2,150	3400
Punta de torre / Tower head / Porte-flèche верхняя секция башни / kulenin kafa bölümü / رأس البرج			6,164	1,200	1,350	1210
Conjunto asiento pista, punta de torre, orientación y elevación Slewing table assembly, tower head, slewing and hoisting mechanism Groupe pivot + porte-flèche + mécanisme d'orientation + de levage Сиденье площадки + верхняя секция башни + поворотный механизм + подъемный механизм Göbek + kulenin kafa bölümü + mekanizma + vinç kulesi مجموعة وحدة الدوارن + رأس البرج + آلية الدوران + آلية الرفع			8,5	1,920	2,440	5660
Tramo de pluma Jib section Tronçon de flèche Секция стрелы Vom bölümü أجزاء الذراع	P14-21N (I) P14-22N (II) P14-23N (III) P14-24N (IV) P14-25N (V) P14-26N (VI)		10,150 10,160 10,160 10,160 5,267 10,156	1,366 1,226 1,226 1,226 1,226 1,226	1,665 1,646 1,547 1,547 1,665 1,737	965 945 785 655 345 530
Polipasto / Hook assembly / Palan / Полуспаст / Kanca takımı / بكرة	SR DR		0,76 1	0,160 0,235	0,960 1,288	190 293
Carro / Trolley / Chariot / Грузовая тележка / Şaryo / عربية	SR DR		1,100 1,410	1,330 1,471	0,730 1,204	195 295
Contrapluma con plataformas / Counterjib with platforms Contre-flèche avec plateformes / Противовесная консоль с платформами / Platformlu kuuyruk / الذراع المقابل مع المنصة			10,70	1,410	0,430	1575
Plataforma y cabina / Platform and cabin / Plateforme et cabine Платформа и кабина / Platform ve kabin / منصة وكابينة			3,760	2,050	2,400	1280
Contrapeso / Counterweight / Contrepoids / Противовес / Denge ağırlığı / موازن معاكسة / Grande / Big / Grand / Большой / Büyük / كبير / Pequeño / Small / Petit / Малый / Küçük / صغير			1,08 1,08	0,50 0,50	2,02 1,30	2360 1500
Lastre / Ballast / Lest / Балласт / Alt ağırlık taşları / ثقل			3,800	0,580	1,500	6000
Estructura torre de montaje / Jacking cage structure / Structure de tour de montage / Структура монтажной башни / Kaldırma kafesi yapısı / هيكل برج التركيب	TM 6-150		10,320	2,420	2,410	3500

LASTRES INFERIORES / LOWER BALLASTS / LESTS INFÉRIEURS / НИЖНИЙ БАЛЛАСТ / ALT AĞIRLIK TAŞLARI / ثقل

J85

BN 38-150	H (m)	13,6		25,4		40,1	
	P (t)	36		48		72	
BNI 45-100	H (m)	19,4	31,2	40,1	46	51,9	
	P (t)	36	48	60	72	84	
BNI 6-150	H (m)	28	37	45,8	54,7	60,8	
	P (t)	36	48	60	72	96	

H: Altura bajo gancho / Height under hook / Hauteur maximale sous crochet / Высота под крюком / Kanca alti yüksekliği / الارتفاع أسفل الخطاف
 Para alturas intermedias tomar el lastre correspondiente a la altura superior / For intermediate heights take the ballast corresponding to the higher height / Pour les hauteurs intermédiaires, opter pour le lest correspondant à la hauteur immédiatement supérieure / Для промежуточных высот возьмите балласт, соответствующий большей высоте / Orta yükseklikler için daha üst bir yüksekliğe karşılık gelen ağırlığı alıniz / للارتفاعات البينية يرجى استخدام الثقل العائد للارتفاع الأعلى /



Fecha / Date: 18/02/2021

FEM 1001

Reservado el derecho a modificaciones sin previo aviso. Declinamos toda responsabilidad derivada de la información proporcionada / Subject to modification, without previous warning. This information is supplied without liability / L'entreprise se réserve le droit de procéder à des modifications sans préavis. Nous déclinons toute responsabilité quant aux informations fournies / Мы оставляем за собой право на внесение изменений без предварительного уведомления. Мы снимаем с себя любую ответственность в отношении предоставленной информации / Önceden bildirilmeksizin değiştirilme hakkı saklıdır. Verilen bilgiler için hiçbir sorumluluk kabul etmemekteyiz / حقوق التغيير محفوظة دون إشعار مسبق. دون أدنى مسؤولية عن المعلومات المقدمة

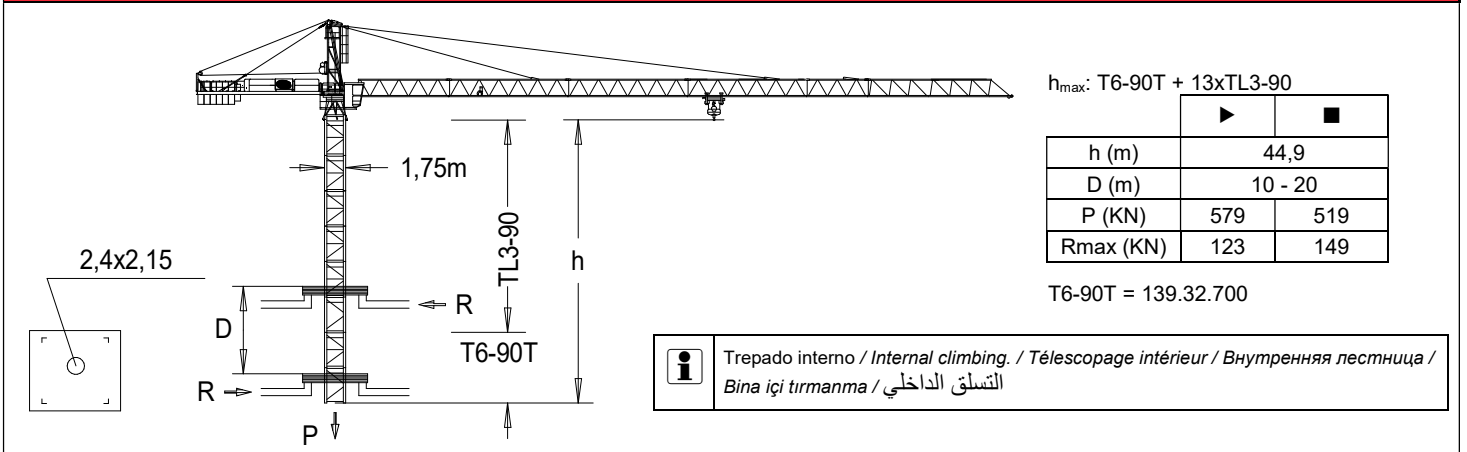
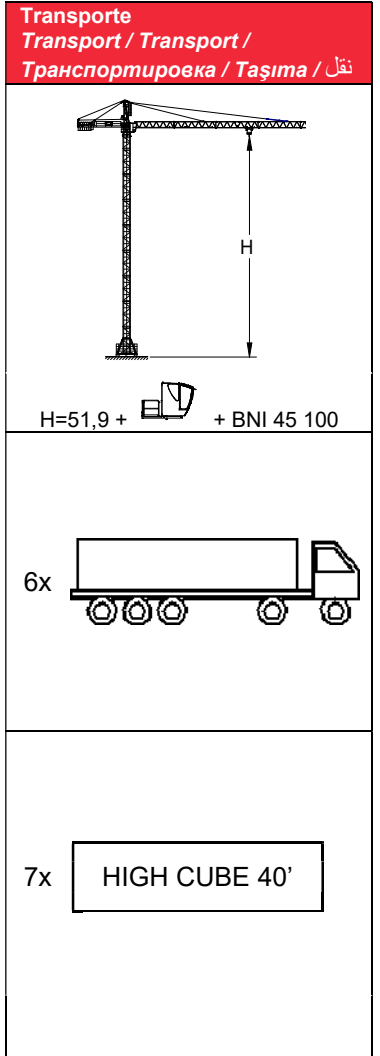
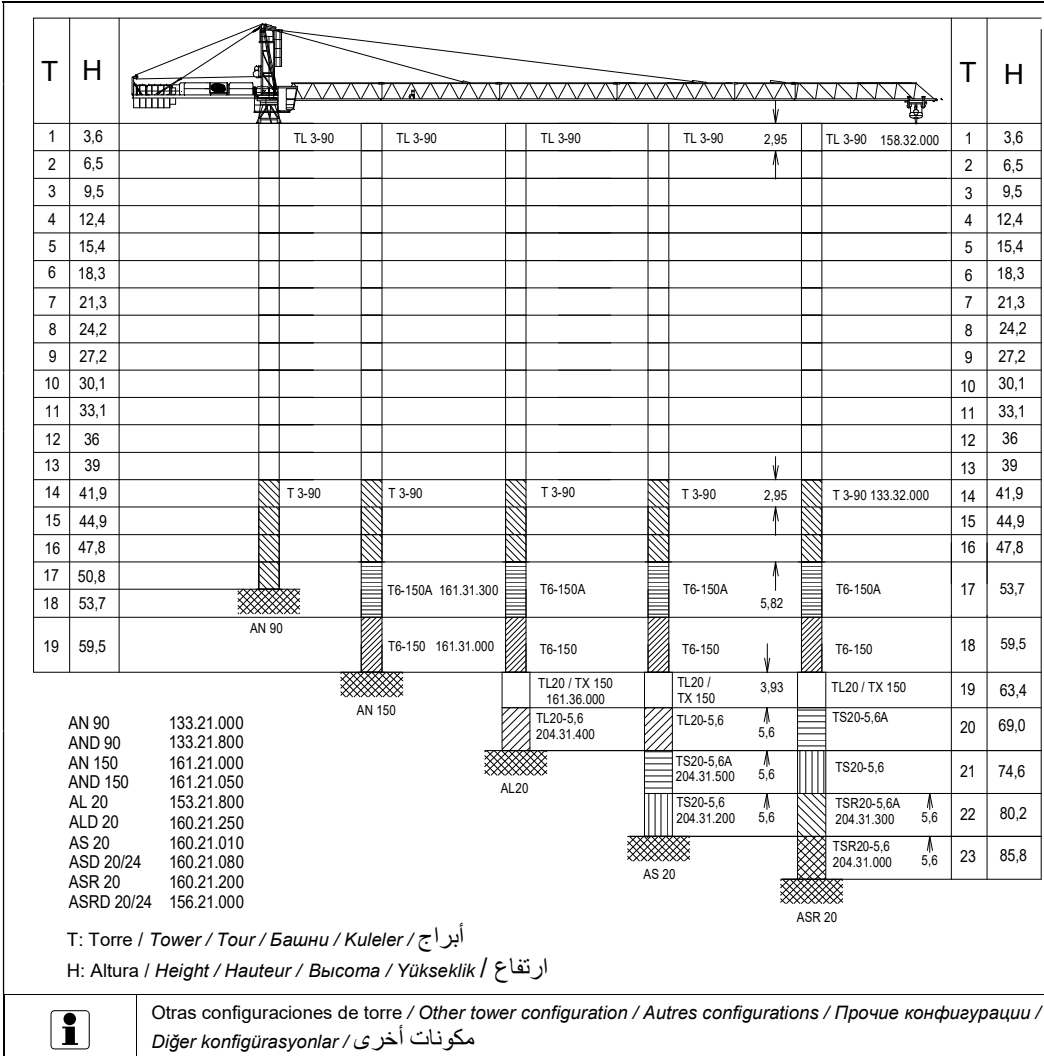

- ⚠️ Viento fuera de servicio / Out of service wind / Vitesse du vent hors service / Ветровая нагрузка в покое / Rüzgar devre dışı / الريح خارج الخدمة
- 📄 Consultar / Consult / Nous consulter / Консультируйтесь / Danışınız / الرجوع إلى
- ▶ En servicio / In service / En service / В работе / Devrede / في الخدمة
- Fuera de servicio / Out of service / Hors service / В покое / Devre dışı / خارج الخدمة



Ctra./Rd. Madrid - Irún Km. 415 - 20.213 IDIAZABAL [Gipuzkoa] ESPAÑA / SPAIN
P.O. Box, 23 - 20.200 BEASAIN - E-mail: jaso@jaso.com
Tel. +34 943 - 18 70 00 • Fax. +34 943 - 18 70 20
www.jaso.com

Fecha / Date: 18/02/2021

Reservado el derecho a modificaciones sin previo aviso. Declinamos toda responsabilidad derivada de la información proporcionada / Subject to modification, without previous warning. This information is supplied without liability / L'entreprise se réserve le droit de procéder à des modifications sans préavis. Nous déclinons toute responsabilité quant aux informations fournies / Мы оставляем за собой право на внесение изменений без предварительного уведомления. Мы снимаем с себя любую ответственность в отношении предоставленной информации / Önceden bildirilmeksizin değiştirilme hakkı saklıdır. Verilen bilgiler için hiçbir sorumluluk kabul etmemekteyiz / حقوق التغيير محفوظة دون إشعار مسبق. دون أدنى مسؤولية عن المعلومات المقدمة

FEM 1001

DELEGACION / DEALER