

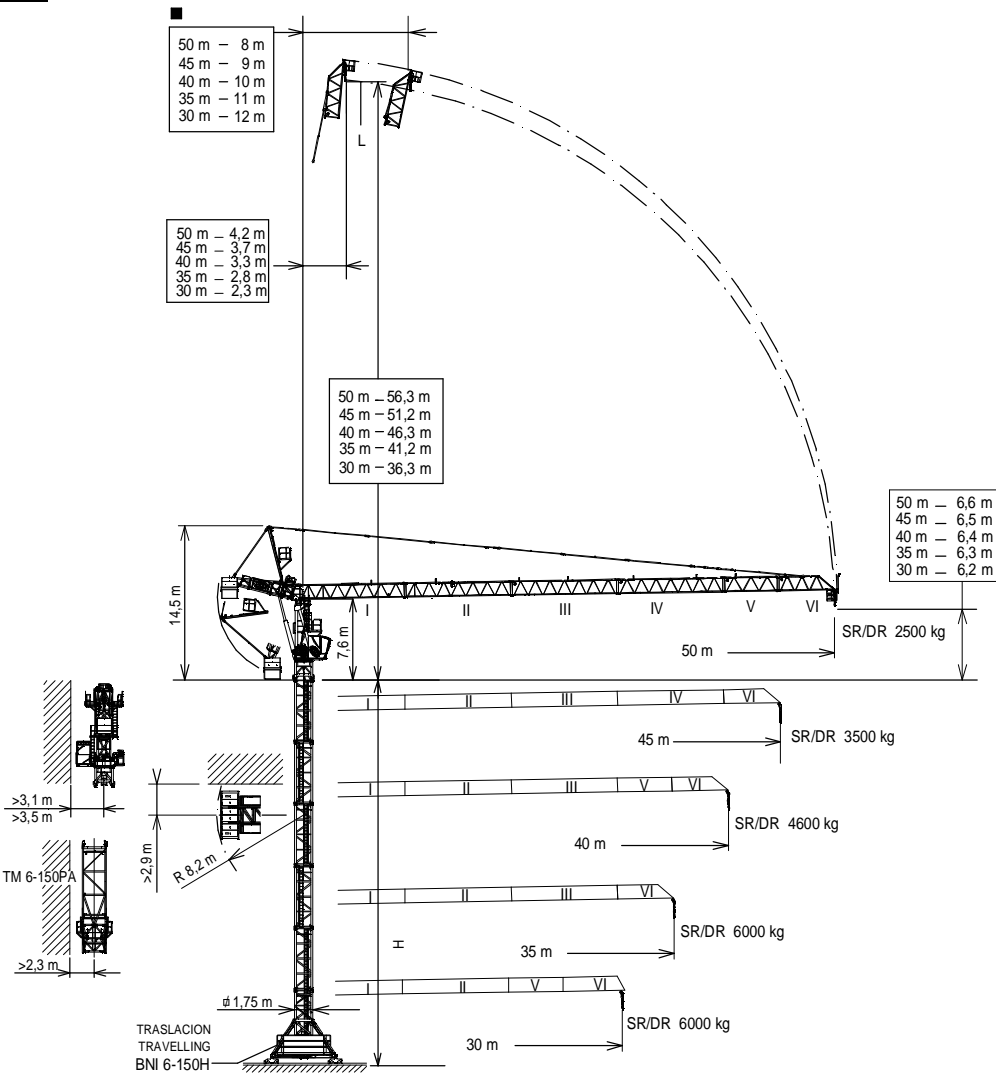

EN 14439
C25

UNE-EN-ISO 9001



H = Máxima altura de torre sin arriostrar (m).
Maximum tower height without fastening (m).
Hauteur maximale de tour sans ancrage (m).
Максимальная высота башни без крепления (м).
Desteksiz maksimum kule yüksekliği (m).
أقصى ارتفاع للبرج دون راس (م)

* Tramo pluma / Jib section / Tronçon de flèche / Секция стрелы / Bom bölümü / أجزاء الذراع
** Punta de pluma / Jib end / Pointe de flèche / Конец стрелы / Bom ucu / مقدمة الذراع

*Tramo pluma I / Jib section I ----- 208.40.000
*Tramo pluma II / Jib section II ----- 208.41.000
*Tramo pluma III / Jib section III --- 208.42.000
*Tramo pluma IV / Jib section IV --- 208.43.000
*Tramo pluma V / Jib section V --- 208.44.200
*Tramo pluma VI / Jib section VI --- 208.45.700
**Punta pluma/Jib end ----- 208.45.000

TM 6-150PA -----161.35.500
T3-150-----161.32.000
T6-150-----161.31.000
TD6-150 -----161.31.700
T12-150 ----- 161.31.500
AN 150 -----161.21.000
BNI 6-150 -----161.20.000
ABH 100 -----201.23.000

(H) TRASLACIÓN / TRAVELLING /

TRASLATION / ПЕРЕМЕЩЕНИЕ / RAY YÜRÜYÜŞLÜ / متحركة

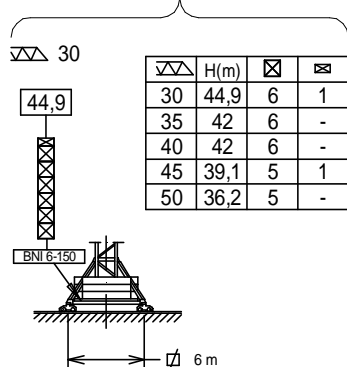

(H) ESTACIONARIA / STATIONARY /

STATIONAIRE / СТАЦИОНАРНОЕ СОСТОЯНИЕ / SABIT / ثابتة

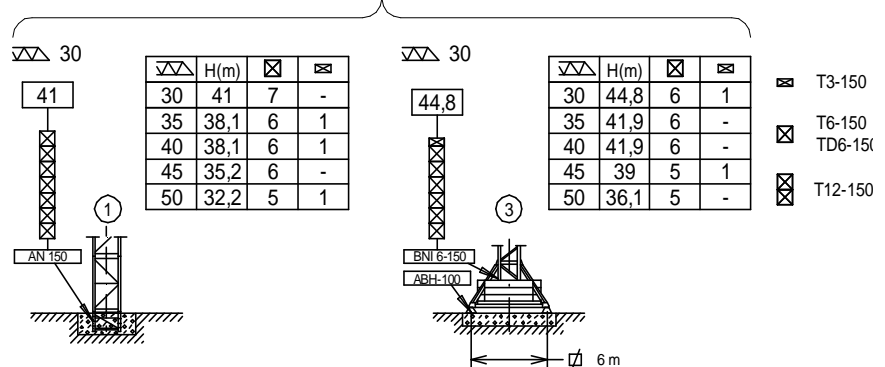



Fecha / Date: 10/06/2019

FEM 1005 - C25













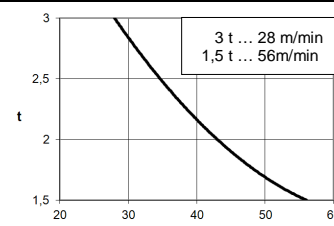
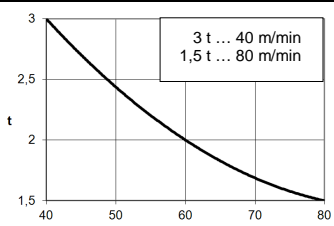
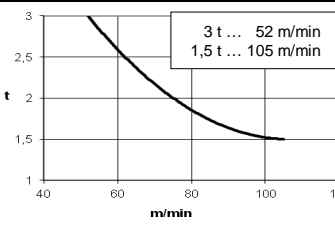

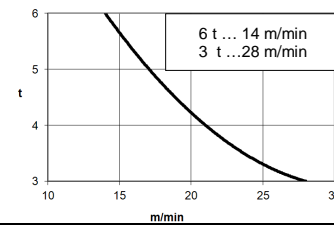
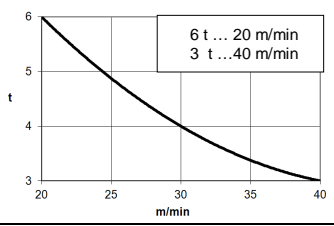
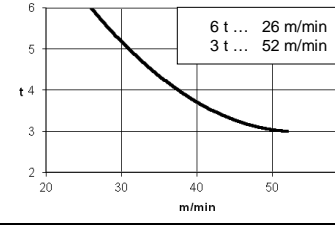



Reservado el derecho a modificaciones sin previo aviso. Declinamos toda responsabilidad derivada de la información proporcionada / Subject to modification, without previous warning. This information is supplied without liability / L'entreprise se réserve le droit de procéder à des modifications sans préavis. Nous déclinons toute responsabilité quant aux informations fournies / Мы оставляем за собой право на внесение изменений без предварительного уведомления. Мы снимаем с себя любую ответственность в отношении предоставленной информации / Önceden bildirilmeksizin değiştirilme hakkı saklıdır. Verilen bilgiler için hiçbir sorumluluk kabul etmemekteyiz حقوق التغيير محفوظة دون إشعار مسبق. دون أدنى مسؤولية عن المعلومات المقدمة

 SR/DR (kg)		Cargas máximas / Maximum loads / Charges maximales / Максимальные нагрузки / Maksimum yük / أقصى حمولة SR/DR - 3000/6000 kg					
 [m]	3000/6000 kg @ ... (m)	Alcance del gancho [m] / Hook reach [m] / Portée du crochet (m) / Радиус действия крюка (m) / Kancanın yüksekliği (m) / مدى الخطاف (m)					
		25	30	35	40	45	50
50 m	47,4/28,6	3000/6000	3000/5685	3000/4725	3000/3965	3000/3310	2500
45 m	45,0/31,5	3000/6000	3000/6000	3000/5310	3000/4470	3000/3500	—
40 m	40,0/34,1	3000/6000	3000/6000	3000/5815	3000/4600	—	—
35 m	35,0	3000/6000	3000/6000	3000/6000	—	—	—
30 m	30,0	3000/6000	3000/6000	—	—	—	—

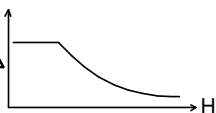
CARACTERÍSTICAS DE MECANISMOS / MECHANISMS FEATURES / CARACTÉRISTIQUES DES

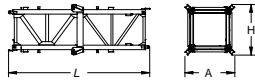
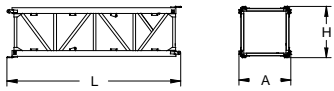
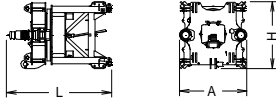
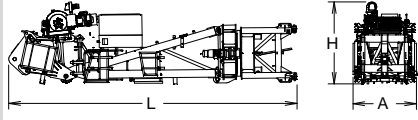
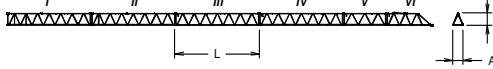
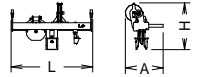
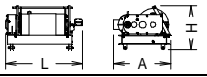
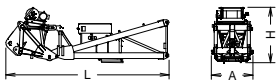
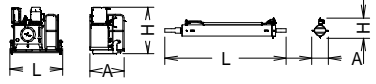
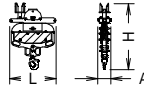
MÉCANISMES / ХАРАКТЕРИСТИКИ МЕХАНИЗМОВ / MEKANİZMALARIN ÖZELLİKLERİ / الخصائص الآلية

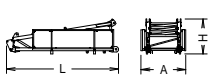
*opcional *optional *en option *опция *opsiyonel *اختياري				
	EC2556VF 18,4 kW	*EC3380VF 24,2 kW	EC40105VF 29,4 kW	
 t m/min				
 t m/min				
				$H \leq \begin{matrix} \text{SR} & 452 \text{ m} \\ \text{DR} & 226 \text{ m} \end{matrix}$
				 400V 50Hz
TG2020VF 2x7,3 kW	OG1108VF 2x4 kW	EPH2020VF 15 kW	TH1506 11 kW	$P_{TOTAL} (EC2556VF + OG1108VF + EPH2020VF) = 41,4 \text{ kW}$ $P_{TOTAL} (*EC3380VF + OG1108VF + EPH2020VF) = *47,2 \text{ kW}$
0...20 m/min	0... 0,8 r/min sl/min	2 min	0,6 m/min	  

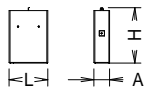
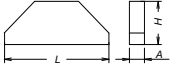
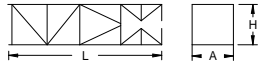
DENOMINACIÓN / DENOMINATION / DÉSIGNATION / НАЗВАНИЕ / AÇIKLAMA / اسم	L [m]	A [m]	H [m]	P / W [kg]
Torre inferior / Lower tower / Tour inférieure / Нижняя башня Alt kule / البرج السفلي TI-6-150				
Torre / Tower / Tour Башня / Kule / برج T6-150 TD6-150 TT6-150 T3-150 T12-150				
Torre asiento pista + base punta de torre + orientación Slewing table + tower head base + slewing mechanism Tour pivot + base du porte-flèche + mécanisme d'orientation Сиденье площадки + основание верхней секции башни + поворотный механизм Göbek +kule kafa bölümü tabanı+mekanizma / رج وحدة الدوارن + قاعدة رأس البرج + آلية الدوران				
Conjunto asiento pista, punta de torre, orientación y elevación Slewing table assembly, tower head, slewing and hoisting mechanism Groupe pivot + porte-flèche + mécanisme d'orientation + de levage Сиденье площадки + верхняя секция башни + поворотный механизм + подъемный механизм Göbek +kulenin kafa bölümü+mekanizma+vinç kulesi مجموعة وحدة الدوارن + رأس البرج + آلية الدوران + آلية الرفع				
Tramo de pluma Jib section Tronçon de flèche Секция стрелы Вот bölümü أجزاء الذراع				
Punta de pluma / Jib end / Pointe de flèche / Конец стрелы / Вот иси / مقدمة الذراع				
Mecanismo elevación carga / Hoisting mechanism / mécanisme de levage/ подъемный механизм / Vinç kulesi / آلية الرفع				
Punta de torre + Elevación carga / Tower head + hoisting mechanism Porte-flèche + mécanisme de levage / Верхняя секция башни + подъемный механизм Kulenin kafa bölümü + Vinç kulesi / رأس البرج + آلية الرفع				
Elevación pluma con plataforma / Luffing mech + platform / Relevage de flèche + plateforme + Подъем стрелы + Платформа + Yük kaldırma ve indirme + Platform / رافع الذراع + كابينة / Cilindro hidráulico / Hydraulic cylinder / Cylindre hydraulique /				
Polipasto / Hook assembly / Palan / Полуспаст / Kanca takımı / ككرة / Gancho / Hook				
Tirante sostén pluma / Jib support tie / Tirant de flèche / Растяжка поддержки стрелы / Kol destek bağları / مشد دعامة الذراع				
Contrapluma con plataformas + Soporte contrapeso / Counterjib with platforms + Counterweight support Contre-flèche avec plateformes / Противовесная консоль с платформами / Platformlu kuçruk / الذراع المقابل مع المنصة				
Parte superior Top part				
Plataforma y cabina / Platform and cabin / Plateforme et cabine Платформа и кабина / Platform ve kabin / منصة وكابينة				
Contrapeso / Counterweight / Contrepoids / Противовес / Denge ağırlığı / اوزان معاكسة				
Lastre / Ballast / Lest / Балласт / Alt ağırlık taşları / ثقل				
Estructura torre de montaje / Jacking cage structure / Structure de tour de montage / Структура монтажной башни / Kaldırma kafesi yapısı / هيكل برج التركيب				



Fecha / Date: 10/06/2019

FEM 1005 - C25

Reservado el derecho a modificaciones sin previo aviso. Declinamos toda responsabilidad derivada de la información proporcionada / Subject to modification, without previous warning. This information is supplied without liability / L'entreprise se réserve le droit de procéder à des modifications sans préavis. Nous déclinons toute responsabilité quant aux informations fournies / Мы оставляем за собой право на внесение изменений без предварительного уведомления. Мы снимаем с себя любую ответственность в отношении предоставленной информации / Önceden bildirilmeksizin değiştirilme hakkı saklıdır. Verilen bilgiler için hiçbir sorumluluk kabul etmemekteyiz / حقوق التغيير محفوظة دون إشعار مسبق. دون أدنى مسؤولية عن المعلومات المقدمة

COMPOSICIONES DE TORRE / TOWER COMPOSITIONS

COMPOSITIONS DE LA TOUR / КОНСТРУКЦИЯ БАШНИ / KULE KOMPOZİSYONLARI / مكونات البرج

J168HPA

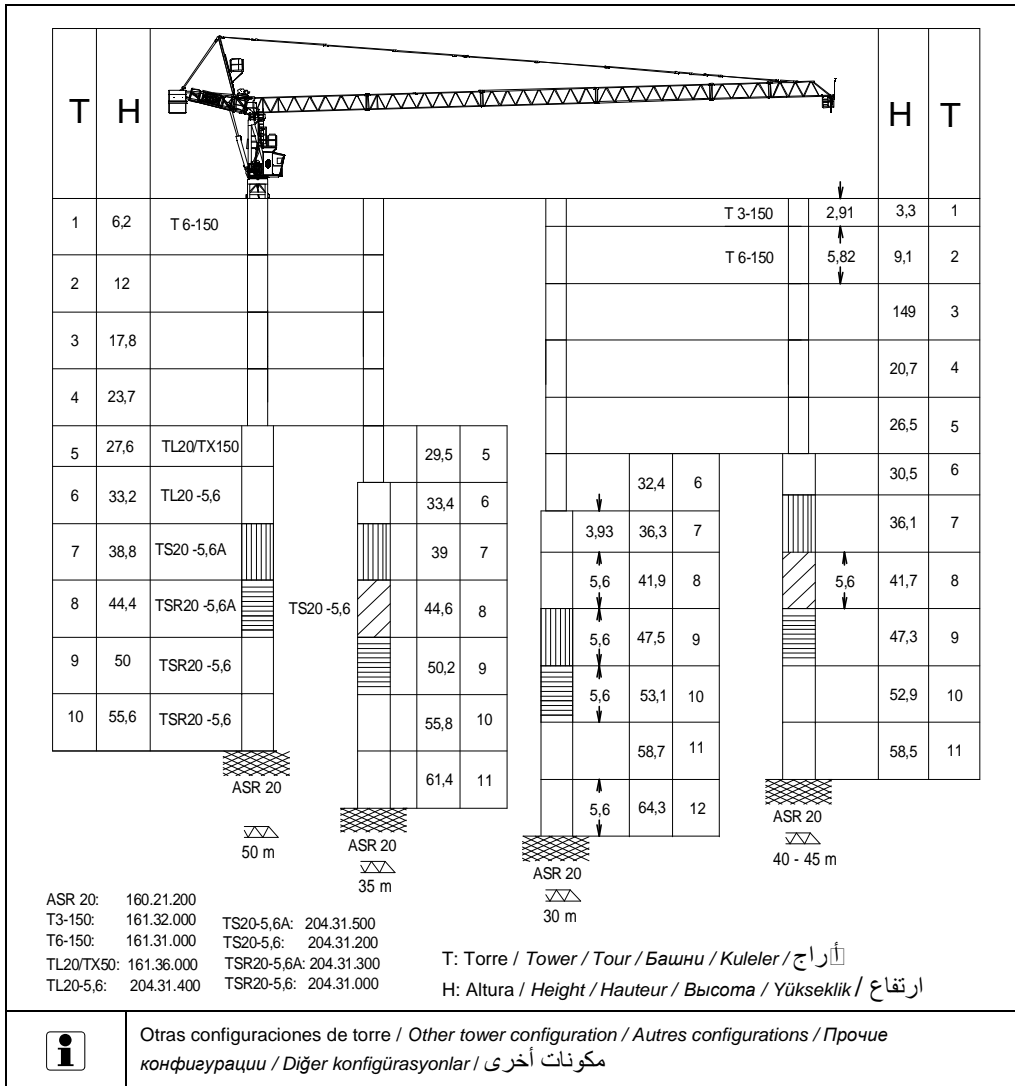

Transporte / Transport / Transport / Транспортировка / Taşıma / نقل

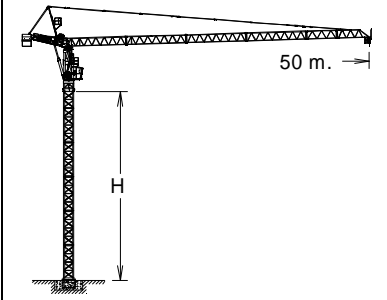

H=32,2 + + AND150

6x



6x

HIGH CUBE 40'

TREPADO / CLIMBING / TÉLESCOPAGE / ЛЕСТНИЦА / TIRMANMA / التسلق

J168HPA

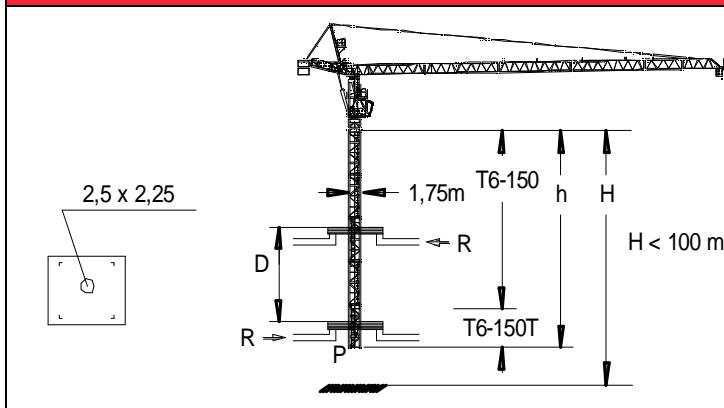

h_{max}: T6150T + 4xT6-150

h (m)	29,1
D (m)	12 - 14
P (KN)	775 / 715
Rmax (KN)	150 / 303

T6-150T: 161.32.500

Trepado interno / Internal climbing. / Télescopage intérieur / Внутренняя лестница / Bina içi tirmanma / التسلق الداخلي

- Viento fuera de servicio / Out of service wind / Vitesse du vent hors service / Ветровая нагрузка в покое / Rüzgar devre dışı / الريح خارج الخدمة
- Consultar / Consult / Nous consulter / Консультируйтесь / Danışınız / الرجوع إلى
- En servicio / In service / En service / В работе / Devrede / في الخدمة
- Fuera de servicio / Out of service / Hors service / В покое / Devre dışı / خارج الخدمة



Ctra./Rd. Madrid - Irún Km. 415 - 20.213 IDIAZABAL [Gipuzkoa] ESPAÑA / SPAIN
 P.O. Box, 23 - 20.200 BEASAIN - E-mail: jaso@jaso.com
 Tel. +34 943 - 18 70 00 • Fax. +34 943 - 18 70 20
www.jaso.com

Fecha / Date: 10/06/2019

FEM 1005 - C25

DELEGACION / DEALER

Reservado el derecho a modificaciones sin previo aviso. Declinamos toda responsabilidad derivada de la información proporcionada / Subject to modification, without previous warning. This information is supplied without liability / L'entreprise se réserve le droit de procéder à des modifications sans préavis. Nous déclinons toute responsabilité quant aux informations fournies / Мы оставляем за собой право на внесение изменений без предварительного уведомления. Мы снимаем с себя любую ответственность в отношении предоставленной информации / Önceden bildirilmeksizin değiştirilme hakkı saklıdır. Verilen bilgiler için hiçbir sorumluluk kabul etmemekteyiz /

حقوق التغيير محفوظة دون إشعار مسبق. دون أدنى مسؤولية عن المعلومات المقدمة