

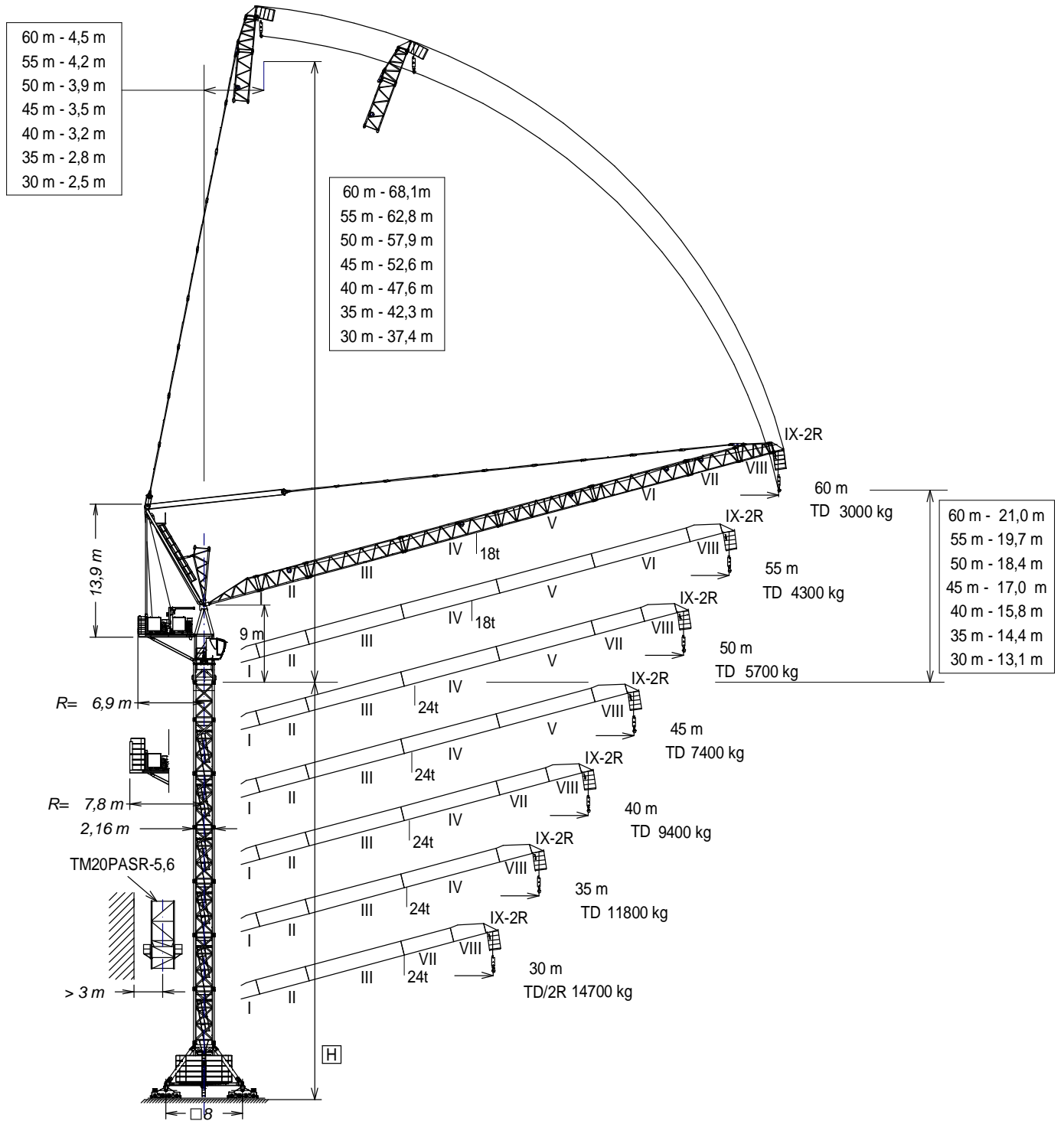

UNE 58-101  
FEM 1001

UNE-EN-ISO 9001



H = Máxima altura de torre sin arristrar (m).  
Maximum tower height without fastening (m).  
Hauteur maximale de tour sans ancrage (m).  
Максимальная высота башни без крепления (m).  
Desteksiz maksimum kule yüksekliği (m).  
أقصى ارتفاع للبرج بدون ربط (م)

\* Tramo pluma / Jib section / Tronçon de fleche  
Секция стрелы / Bom bölümü / أجزاء الذراع

*Tramo pluma I / Jib setion I	204.40.000	BSR18-20-5,6	204.20.000
*Tramo pluma II / Jib setion II	204.41.500	ASR20	160.21.200
*Tramo pluma III / Jib setion III	204.42.500	TSR20	153.31.800
*Tramo pluma IV / Jib setion IV	204.43.500	TSR20-5,6	204.31.000
*Tramo pluma V / Jib setion V	204.44.500	TM20PASR-5,6	206.35.000
*Tramo pluma VI / Jib setion VI	204.45.500	ABH100B	204.23.000
*Tramo pluma VII / Jib setion VII	204.46.500	ABH100H	156.23.500
*Tramo pluma VIII / Jib setion VIII	204.47.000		
*Tramo pluma IX-2R / Jib setion IX-2R	204.49.500		

Fecha / Date: 01/09/2017



Reservado el derecho a modificaciones sin previo aviso. Declinamos toda responsabilidad derivada de la información proporcionada / Subject to modification, without previous warning. This information is supplied without liability / L'entreprise se réserve le droit de procéder à des modifications sans préavis. Nous déclinons toute responsabilité quant aux informations fournies / Мы оставляем за собой право на внесение изменений без предварительного уведомления. Мы снимаем с себя любую ответственность в отношении предоставленной информации / Önceden bildirilmeksizin değiştirilme hakkı saklıdır. Verilen bilgiler için hiçbir sorumluluk kabul etmemekteyiz



TD

(H) TRASLACIÓN / TRAVELLING /

TRASLATION / ПЕРЕМЕЩЕНИЕ / RAY YÜRÜYÜŞLÜ / متحركة

(H) ESTACIONARIA / STATIONARY /

STATIONAIRE / СТАЦИОНАРНОЕ СОСТОЯНИЕ / SABIT / ثابتة

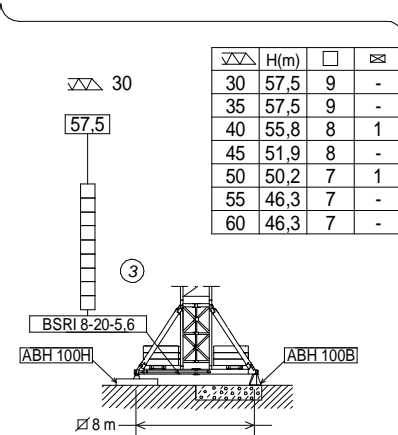
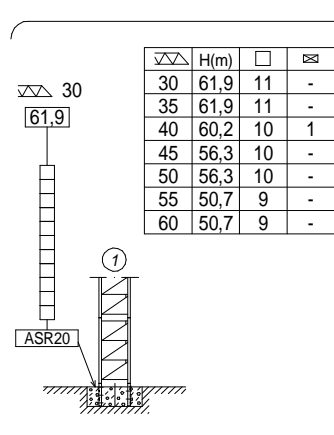
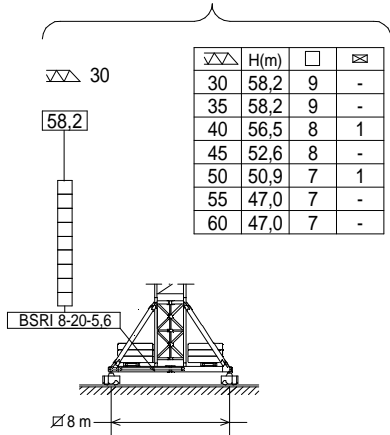

⊠ TSR20  
□ TSR20-5,6

TD / 2R

(H) TRASLACIÓN / TRAVELLING /

TRASLATION / ПЕРЕМЕЩЕНИЕ / RAY YÜRÜYÜŞLÜ / متحركة

(H) ESTACIONARIA / STATIONARY /

STATIONAIRE / СТАЦИОНАРНОЕ СОСТОЯНИЕ / SABIT / ثابتة

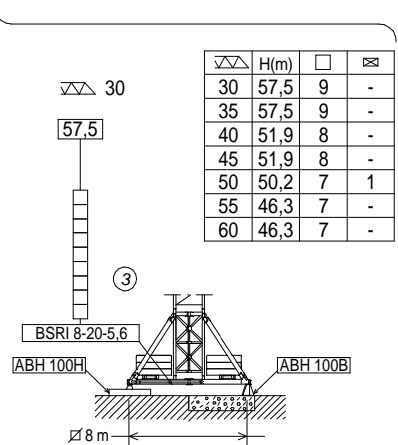
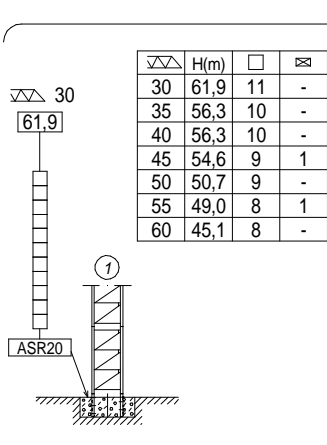
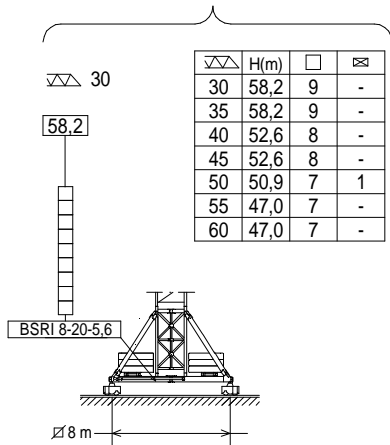

⊠ TSR20  
□ TSR20-5,6

TREPADO / CLIMBING / TÉLESCOPAGE / ЛЕСТНИЦА / TIRMANMA / التسلق

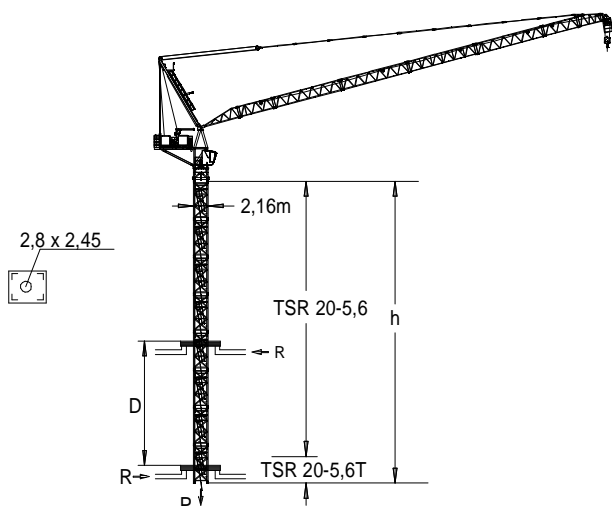

$h_{max}: \text{TSR20-5,6T} + 7 \times \text{TSR20-5,6}$

h (m)	44,8
D (m)	13,4 - 21
P (KN)	1558 1378
Rmax (KN)	447 698

TSR20-5,6T: 204.31.700

**i** Trepado interno / Internal climbing. / Télescopage intérieur / Внутренняя лестница / Bina içi tirmanma / التسلق الداخلي



- Viento fuera de servicio / Out of service wind / Vitesse du vent hors service / Ветровая нагрузка в покое / Rüzgar devre dışı / الريح خارج الخدمة
- Consultar / Consult / Nous consulter / Консультируйтесь / Danışınız / الرجوع الى
- En servicio / In service / En service / В работе / Devrede / في الخدمة
- Fuera de servicio / Out of service / Hors service / В покое / Devre dışı / خارج الخدمة







Fecha / Date: 01/09/2017













Reservado el derecho a modificaciones sin previo aviso. Declinamos toda responsabilidad derivada de la información proporcionada / Subject to modification, without previous warning. This information is supplied without liability / L'entreprise se réserve le droit de procéder à des modifications sans préavis. Nous déclinons toute responsabilité quant aux informations fournies / Мы оставляем за собой право на внесение изменений без предварительного уведомления. Мы снимаем с себя любую ответственность в отношении предоставленной информации / Önceden bildirilmeksizin değiştirilme hakkı saklıdır. Verilen bilgiler için hiçbir sorumluluk kabul etmemekteyiz / حقوق التغيير محفوظة دون إشعار مسبق. دون أدنى مسؤولية عن المعلومات المقدمة

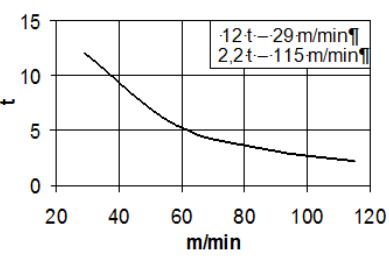
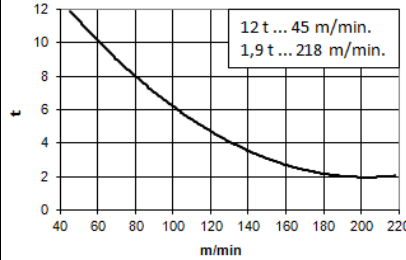

 TD (Kg)		Cargas máximas / Maximum loads / Charges maximales / Максимальные нагрузки / Maksimum yük / أقصى حمولة <b>TD-12.000 kg</b>							
 [m]	12000 kg @ ... (m)	Alcance del gancho [m] / Hook reach [m] / Portée du crochet (m) / Радиус действия крюка (m) / Kancanın yüksekliği (m) / مدى الخطاف							
		25	30	35	40	45	50	55	60
60 m	33,7	12000	12000	11240	8810	6905	5370	4095	3000
55 m	33,8	12000	12000	11340	8960	7100	5575	4300	—
50 m	34,0	12000	12000	11470	9100	7230	5700	—	—
45 m	34,2	12000	12000	11600	9265	7400	—	—	—
40 m	34,5	12000	12000	11740	9400	—	—	—	—
35 m	34,6	12000	12000	11800	—	—	—	—	—
30 m	30,0	12000	12000	—	—	—	—	—	—

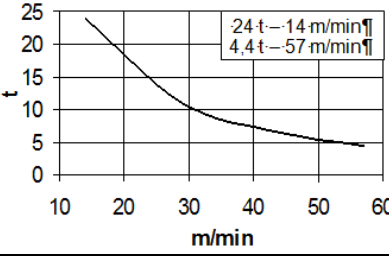
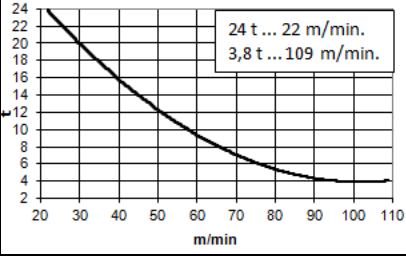
 /  TD/2R (kg)			Cargas máximas / Maximum loads / Charges maximales / Максимальные нагрузки / Maksimum yük / أقصى حمولة <b>TD/2R (kg)</b>							
 [m]	2R 24000 kg @ ... (m)	TD 12000 kg @ ... (m)	Alcance del gancho [m] / Hook reach [m] / Portée du crochet (m) / Радиус действия крюка (m) / Kancanın yüksekliği (m) / مدى الخطاف							
			25	30	35	40	45	50	55	60
60 m	33,4	12000	12000	11080	8600	6670	5110	3810	2700	
55 m	33,5	12000	12000	11170	8740	6840	5300	4000	—	
50 m	20,9	33,7	18850	14420	11240	8840	6950	5400	—	
45 m	20,9	33,9	18850	14490	11360	8990	7100	—	—	
40 m	20,8	34,0	18820	14540	11460	9100	—	—	—	
35 m	20,7	34,1	18800	14570	11500	—	—	—	—	
30 m	20,7	30,0	18870	14700	—	—	—	—	—	
 [m]	2R 18000 kg @ ... (m)	TD 9000 kg @ ... (m)	Alcance del gancho [m] / Hook reach [m] / Portée du crochet (m) / Радиус действия крюка (m) / Kancanın yüksekliği (m) / مدى الخطاف							
			25	30	35	40	45	50	55	60
60 m	25,9	39,1	18000	14390	11080	8600	6670	5110	3810	2700
55 m	25,8	39,4	18000	14390	11170	8740	6840	5300	4000	—

**CARACTERÍSTICAS DE MECANISMOS / MECHANISMS FEATURES / CARACTÉRISTIQUES** **J280PA.24.2R**  
**DES MÉCANISMES / ХАРАКТЕРИСТИКИ МЕХАНИЗМОВ / MEKANİZMALARIN ÖZELLİKLERİ / الخصائص الآلية**

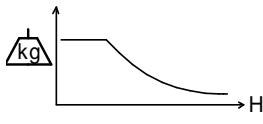
*opcional *optional *en option *опция *opsiyonel *اختياري						
	<b>EC88115VF</b> 65 kW	<b>* EC150218VF</b> 110 kW	<b>TG4025VF</b> 4x7,5 kW	<b>OG2008VF</b> 2x7,3 kW	<b>EP10015VF</b> 75 kW	<b>TH4010</b> 29,4 kW
			0...25 m/min	0... 0,8 r/min sl/min	1,5 min	0,6 m/min
			 400V 50Hz <b>P<sub>TOTAL</sub>(EC88115VF + OG2008VF + EP10015VF) =154,6 kW</b> <b>P<sub>TOTAL</sub>(*EC150218VF + OG2008VF + EP10015VF) =*199,6 kW</b>			
	$H \leq$	TD	874 m			
		2R	437 m	 		

**LISTA DE EMBARQUE / PACKING LIST** **J280PA.24.2R**  
**LISTE DE COLISAGE / СПИСОК ПОСТАВКИ / ÇEKİ LİSTESİ / قائمة التحميل**

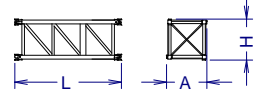
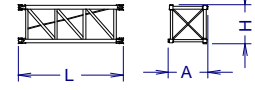
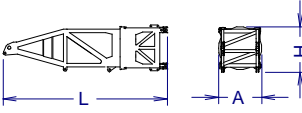
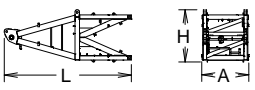
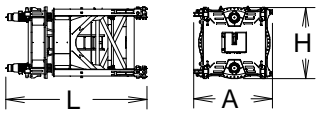
DENOMINACIÓN / DENOMINATION / DÉSIGNATION / НАЗВАНИЕ / AÇIKLAMA / اسم	L [m]	A [m]	H [m]	P / W [kg]
Torre inferior / Lower tower / Tour inférieure / Нижняя башня Alt kule / البرج السفلي / TSRI-20-5,6 	5,990	2,257	2,257	6860
Torre / Tower / Tour / Башня / Kule / برج / TSR20 / TSR20-5,6 	4,260 5,990	2,251 2,257	2,251 2,257	3110 4210
Torre asiento pista, torre superior y orientación / Slewling table, top tower and slewing mechanism / Tour pivot + tour supérieure + mécanisme d'orientation / Сиденье площадки + верхняя башня + поворотный механизм / Göbek + üst kule + mekanizma / برج وحدة الدوران + البرج العلوي + آلية الدوران 	9,560	2,320	2,560	15600
Punta de torre / Top tower / tour supérieure / верхняя башня / Kulenin kafa bölümü / رأس البرج 	5,780	2,110	2,380	4900
Torre asiento pista + base punta de torre + orientación / Slewling table + tower head base + slewing mechanism / Tour pivot + base du porte-flèche + mécanisme d'orientation / Сиденье площадки + основание верхней секции башни + поворотный механизм / Göbek + üst kule + mekanizma / برج وحدة الدوران + البرج العلوي + آلية الدوران 	4,570	2,555	2,315	10700

Fecha / Date: 01/09/2017

 **FEM 1001**







Reservado el derecho a modificaciones sin previo aviso. Declinamos toda responsabilidad derivada de la información proporcionada / Subject to modification, without previous warning. This information is supplied without liability / L'entreprise se réserve le droit de procéder à des modifications sans préavis. Nous déclinons toute responsabilité quant aux informations fournies / Мы оставляем за собой право на внесение изменений без предварительного уведомления. Мы снимаем с себя любую ответственность в отношении предоставленной информации / Önceden bildirilmeksizin değiştirilme hakkı saklıdır. Verilen bilgiler için hiçbir sorumluluk kabul etmemekteyiz / حقوق التغيير محفوظة دون إشعار مسبق. دون أدنى مسؤولية عن المعلومات المقدمة

**LISTA DE EMBARQUE / PACKING LIST**

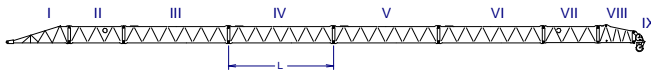
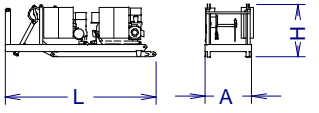
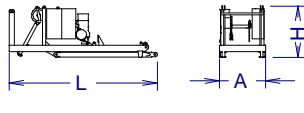
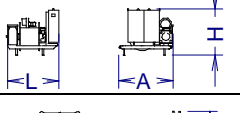
**J280PA.24.2R**

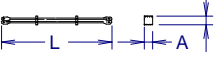
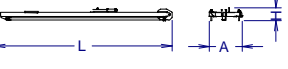
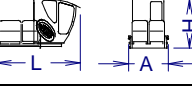
LISTE DE COLISAGE / СПИСОК ПОСТАВКИ / ÇEKİ LİSTESİ / قائمة التحميل

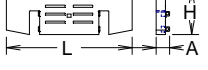
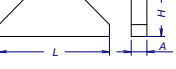
DENOMINACIÓN / DENOMINATION / DÉSIGNATION / НАЗВАНИЕ / AÇIKLAMA / اسم	L [m]	A [m]	H [m]	P / W [kg]		
Tramo de pluma Jib section Tronçon de flèche Секция стрелы Vom bölümü أجزاء الذراع						
[I]	6,265	2,140	1,715	1500		
[II]	5,525	1,580	1,725	1120		
[III]	10,485	1,580	1,725	2225		
[IV]	10,485	1,580	1,725	1856		
[V]	10,485	1,580	1,725	1680		
[VI]	10,485	1,580	1,725	1450		
[VII]	5,575	1,580	1,725	910		
[VIII]	3,695	1,580	1,830	865		
[IX]	1,400	1,580	1,400	825		
Contrapluma con mecanismos, pasteca y plumin Counterjib with mechanisms, reeving block and auxiliary jib Contre-flèche avec mécanismes et fléchette auxiliaire Противовесная консоль с механизмами и вспомогательной дополнительной стрелой Mekanizmalı kuiruk ve yardımcı kol uzantısı الذراع المعاكس مع آليات وريشة مساعدة		7,150	2,200	2,470	21160	
Contrapluma con elevacion pluma, pasteca y plumin Counterjib with luffing mechanisms, reeving block and auxiliary jib Contre-flèche avec mécanisme de relevage de la flèche, moufle et fléchette Противовесная консоль с механизмом подъема стрелы, блоком и дополнительной стрелой Kaldırma kollu, makara düzenekli ve kol uzantılı kuiruk الذراع المعاكس مع رافع الذراع والبكرة والريشة الاضافية		7,150	2,200	2,470	10570	
Mecanismo elevacion carga / Hoisting mechanism / Mécanisme de levage de charge / Подъем груза / Yük kaldırma / رافع الحمولة		2,400	2,135	2,075	9160	
Polipasto / Hook assembly / Palan / Полуспаст / Kanca takımı / بكرة		1,101	0,340	1,692	550	
		0,150	0,278	1,715	240	
Tirante sostén pluma / Jib support tie / Tirant de fleche / Растяжка поддержки стрелы / Kol destek bağları / مشد دعامة الذراع		5,830	0,430	0,480	2095	
Parte superior Top part		11,900	2,200	0,860	5380	
Plataforma y cabina (2 x 1,5) / Platform and cabin / Plateforme et cabine / Платформа и кабина / Platform ve kabin / منصة وكابينة		4,000	1,905	2,335	1190	
Transporte torre de montaje/ Jacking cage transport / Transport de tour de montage / Транспортировка монтажной башни / Kaldırma kafesinin taşınması / نقل برج التركيب		10,820	2,285	2,395	12140	
Contrapeso / Counterweight Contrepoids / Противовес / Denge ağırlığı / اوزان معاكسة		2,200	0,340	0,830	3000	
		4,500	0,340	0,830	6000	
Contrapeso / Counterweight / Contrepoids / Противовес / Denge ağırlığı / اوزان معاكسة	Lastre / Ballast / Lest / Балласт Alt ağırlık taşları / نقل		3,8	0,58	1,5	6000

Fecha / Date: 01/09/2017

 **FEM 1001**



Reservado el derecho a modificaciones sin previo aviso. Declinamos toda responsabilidad derivada de la información proporcionada / Subject to modification, without previous warning. This information is supplied without liability / L'entreprise se réserve le droit de procéder à des modifications sans préavis. Nous déclinons toute responsabilité quant aux informations fournies / Мы оставляем за собой право на внесение изменений без предварительного уведомления. Мы снимаем с себя любую ответственность в отношении предоставленной информации / Önceden bildirilmeksizin değiştirilme hakkı saklıdır. Verilen bilgiler için hiçbir sorumluluk kabul etmemekteyiz / حقوق التغيير محفوظة دون إشعار مسبق. دون أدنى مسؤولية عن المعلومات المقدمة

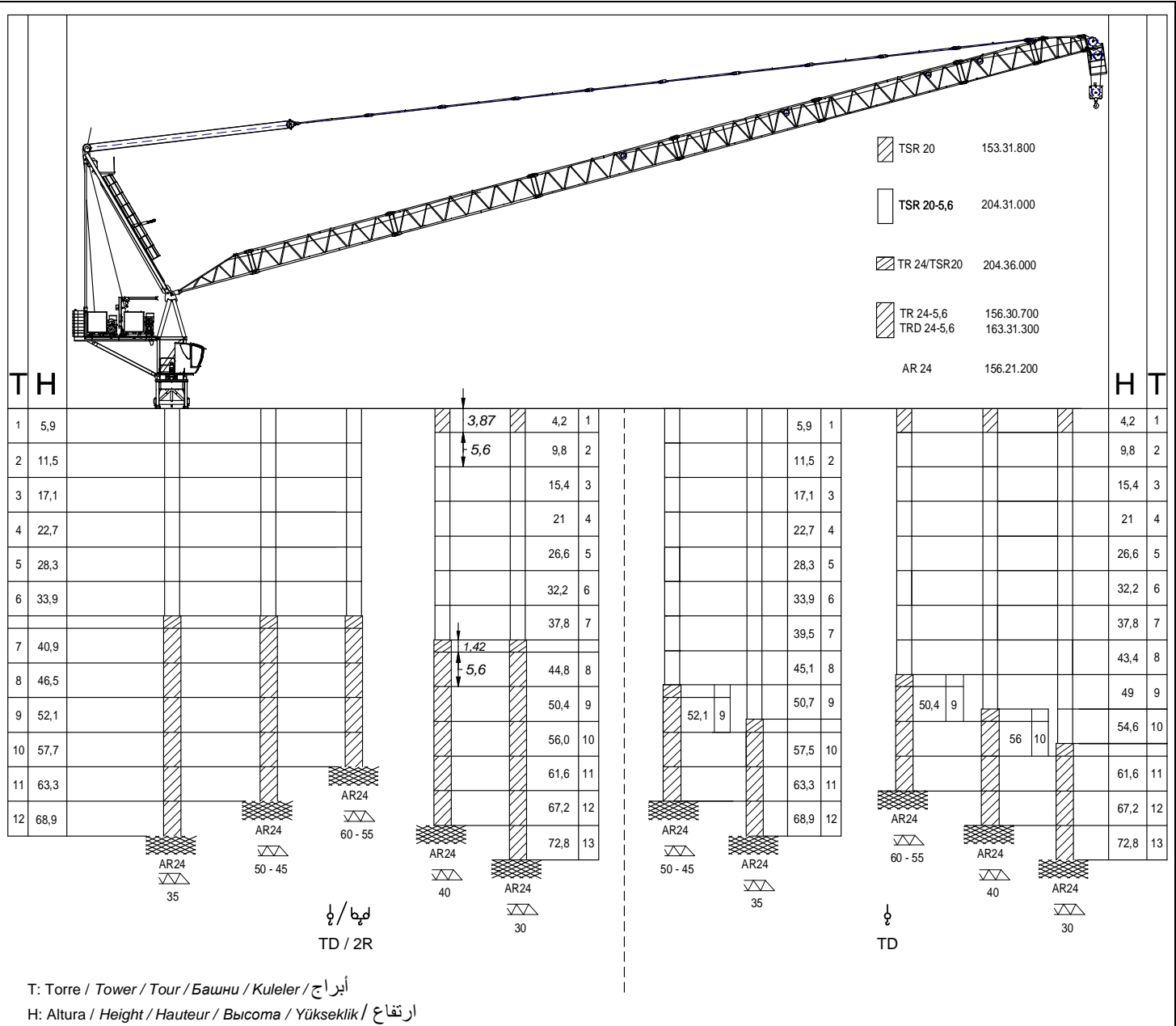

Otras configuraciones de torre / Other tower configuration / Autres configurations / Прочие конфигурации / Diğer konfigürasyonlar / مكونات أخرى

**TRANSPORTE / TRANSPORT / TRANSPORT / ТРАНСПОРТИРОВКА / TAŞIMA | نقل** **J280PA.24.2R**

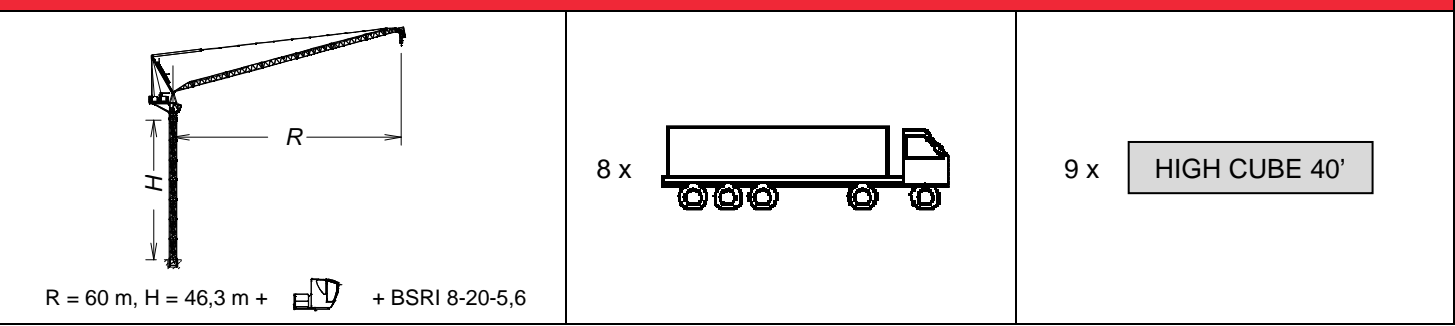

Ctra./Rd. Madrid - Irún Km. 415 - 20.213 IDIAZABAL [Gipuzkoa] ESPAÑA / SPAIN  
 P.O. Box, 23 - 20.200 BEASAIN - E-mail: jaso@jaso.com  
 Tel. +34 943 - 18 70 00 • Fax. +34 943 - 18 70 20  
**www.jaso.com**

Fecha / Date: 01/09/2017

Reservado el derecho a modificaciones sin previo aviso. Declinamos toda responsabilidad derivada de la información proporcionada / Subject to modification, without previous warning. This information is supplied without liability / L'entreprise se réserve le droit de procéder à des modifications sans préavis. Nous déclinons toute responsabilité quant aux informations fournies / Мы оставляем за собой право на внесение изменений без предварительного уведомления. Мы снимаем с себя любую ответственность в отношении предоставленной информации / Önceden bildirilmeksizin değiştirilme hakkı saklıdır. Verilen bilgiler için hiçbir sorumluluk kabul etmemekteyiz /

حقوق التغيير محفوظة دون إشعار مسبق. دون أدنى مسؤولية عن المعلومات المقدمة

**FEM 1001**  
 DELEGACION / DEALER